

A. Basic Keypad Operations

j EZ-Check™ Switch/EZ-Step™ Pushbutton

Slide the switch to select the user stored values for calibration points. Press the button to adjust the output by the user defined step size. Press and hold the button to activate the auto step/ramp mode.

m UNITS/STEP TIME Button

Press and release **UNITS/STEP TIME** to change how current is displayed: either in milliamperes or % of 4-20 mA. Voltage is only displayed in volts.

Press and hold **UNITS/STEP TIME** to change step size. Refer to section H.

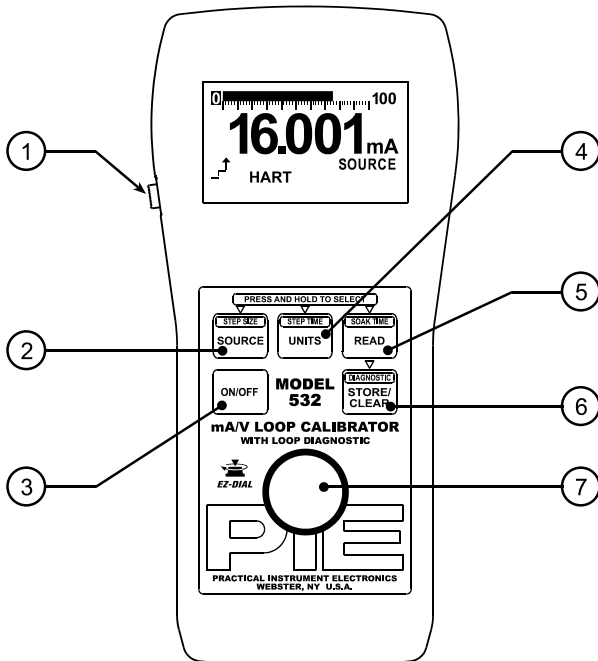

n READ/SOAK TIME Button

Press and release **READ/SOAK TIME** to change read modes. These are:

- Read Milliamps
- Power and Measure 2-Wire Transmitter
- Read Volts

Press and hold **READ/SOAK TIME** to change soak time. Refer to section H.

† STORE/CLEAR/DIAGNOSTIC Button

In any source mode:

Press **STORE/CLEAR/DIAGNOSTIC** to save the current reading in the EZ-Check HI or LO position. The EZ-Check switch must be set to HI or LO. The display will flash "STORED" to confirm.

In any read mode:

Press **STORE/CLEAR/DIAGNOSTIC** to clear the values saved in the EZ-Check HI and LO positions. The display will flash "CLEARED" to confirm.

Press and hold **STORE/CLEAR/DIAGNOSTIC** to activate diagnostic mode. See section I.

k SOURCE/STEP SIZE Button

Press and release **SOURCE/STEP SIZE** to change source modes. These are:

- Source Milliamps
- 2-Wire Transmitter Simulate
- Source Volts

Press and hold **SOURCE/STEP SIZE** to change step size. Refer to section H.

‡ EZ-Dial™ Knob

Turn the EZ-Dial knob to adjust the output level. Press and turn to adjust 100X faster.

l ON/OFF Button

Press **ON/OFF** to turn the Model 532 on or off.



Model 532 Operating Instructions

B. Model 532 Configuration

Press the EZ-Dialä Knob while turning the Model 532 on to access the configuration mode. Turn the EZ-Dialä Knob to select configuration items. Press the EZ-Dialä Knob to change configuration items. Turn the unit off or just wait approximately 8 seconds to exit the configuration mode.

→ AUTO OFF	ON
EZ-STEP	OFF
HART MODE	OFF
EZ-CHECK	OFF
LOOP DIAG	ON
FACTORY RESET	OFF

Auto Off - ON (default)/OFF

Auto Off is ON, by default, to save battery life by turning the unit off after 30 minutes of inactivity. Turn Auto Off to OFF to prevent automatic shutdown. This is typically useful for manual loading or continuous use.

EZ-Stepä - ON/OFF (default)

If EZ-Stepä is ON manual and automatic stepping/ramping is available. If EZ-Stepä is OFF the EZ-Stepä pushbutton will be disabled and the step direction indicator will not be displayed.

HART® Compatibility Mode - ON/OFF (default)

The Model 532 has a HART® compatibility mode. This mode is useful when the devices being powered communicate using the HART® protocol. In this mode the Model 532 connects a 250 Ω load resistor in series with the output in both Source and Power Measure 2-Wire transmitter modes. This eliminates the requirement of an external 250 Ω load resistor. This resistor is typically shown in connection diagrams and manuals for HART® devices.

If HART® Compatibility Mode is ON, a 250 Ω load resistor is automatically switched in series with the output in Source and Power Measure 2-Wire Transmitter modes. The output compliance with HART® Compatibility Mode ON is 950 Ω at 20 mA.

If HART® Compatibility Mode is OFF there is no 250 Ω load resistor in series with the output. This will increase the output compliance voltage to drive 1200 Ω at 20 mA.

EZ-Checkä HI/LO Readings ON/OFF (default)

If the EZ-Checkä HI/LO Readings option is ON, the highest and lowest readings will automatically be saved in the HI and LO EZ-Check™ positions.

If this option is OFF the HI and LO positions will show the current reading.

Loop Diagnostic ON (default)/OFF

Loop Diagnostic may be turned off to prevent entry into diagnostic mode. This may make the Model 532 simpler to operate by eliminating accidental entry into diagnostic mode.

Factory Reset ON/OFF (default)

If Factory Reset is ON, the unit will restore all factory defaults when the Model 532 is turned OFF and back ON. This will reset any changes made in the Model 532 Configuration options, returning the unit to its simplest factory configuration.



Model 532 Operating Instructions

C. EZ-Dialä Knob

Adjust the output up and down with the EZ-Dialä knob. The increment is 0.001 mA (or 0.01 % if display units are % of 4-20 mA.) Press while turning to adjust 100X faster – 0.100 mA (or 1.00 %.)

D. EZ-Checkä Switch

The EZ-Check™ switch has three positions -- high, set, and low. Its position is shown at the left edge of the display with "HI" and "LO" indicators. Use of the EZ-Checkä switch depends on mode:

Source Modes:

Slide the EZ-Checkä switch to the HI and LO positions to recall the settings stored in those positions. While in the HI and LO positions, dial the EZ-Dialä knob to change the display. Press **STORE/CLEAR** to save new settings in the HI and LO positions. The display will flash "STORED" to confirm.

Hint: For faster calibrations, the position of the switch can be felt. This feature allows continuous monitoring of the device being calibrated without looking back at the Model 532 display. This is also useful in poor lighting or under difficult operating conditions.

Read Modes:



In read modes, the Model 532 calibrator records the maximum and minimum readings observed in each mode. Slide the EZ-Checkä switch to the HI and LO positions to display the readings. Press **STORE/CLEAR** to clear the readings. The display will flash "CLEARED" to confirm.

By default, the Model 532 has EZ-Checkä HI/LO Readings OFF. Refer to Model 532 Configuration, section B.

E. EZ-Stepä Pushbutton/ Manual Step

The EZ-Stepä pushbutton is a feature only in source modes.

Press and hold the EZ-Stepä pushbutton for less than one second to cause the output to step up or down by the EZ-Stepä size.

The EZ-Stepä direction is indicated on the display ( or ). Press the EZ-Dialä knob to change the step direction.



Stepping and auto step/ramp limits are defined by the EZ-Checkä HI and LO settings. The step direction changes when a limit is reached.

The step size is computed as the difference between the EZ-Checkä HI and the EZ-Checkä LO divided by the number of steps. See section H.

By default, the Model 532 has EZ-Stepä OFF. Refer to Model 532 Configuration, section B.

F. Auto Step/Ramp

Press the EZ-Stepä pushbutton for more than one second to activate auto step/ramp mode. The Model 532 will automatically step by the selected EZ-Stepä size and time. Press the EZ-Stepä pushbutton again to deactivate auto step/ramp mode.

The EZ-Stepä direction is indicated on the display ( or ). Press the EZ-Dialä knob to change the step direction. The step direction can be changed while automatically stepping/ramping.



Model 532 Operating Instructions

Stepping and auto step/ramp limits are defined by the EZ-Checkä HI and LO settings. The step direction changes when a limit is reached.

Figure 1 shows how the Step/Ramp Parameters are used to configure automatic stepping/ramping.

Figure 1

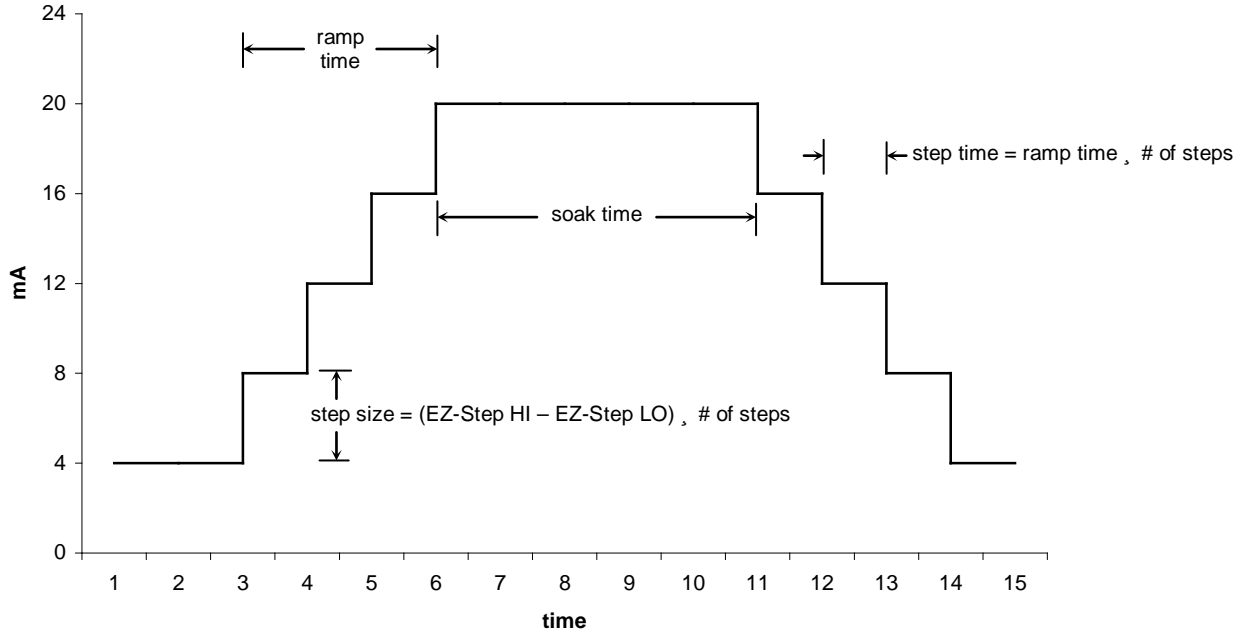

Note: The Model 532's ability to detect overload/undervoltage conditions may be limited by the rate of change in the output when using automatic stepping/ramping. Turn auto step/ramp off while connecting or disconnecting the Model 532.

G. Quick Reference Bar Graph

The Quick Reference Bar Graph indicates the input and output level on the Model 532 in % of 4-20 mA with 1% resolution.



Model 532 Operating Instructions

H. Manual Step and Auto Step/Ramp Parameter

To Change the EZ-Stepä Size:

1. Press and hold the SOURCE/STEP SIZE button for more than $\frac{3}{4}$ of a second.
2. The display will flash "EZ-STEP SIZE".
3. Turn the EZ-Dialä knob to select from 2 to 16 steps between the EZ-Checkä limits.
4. Turn the EZ-Dialä clockwise past 16 steps to select continuous ramp mode.
5. Press the SOURCE/STEP SIZE button again to return to the normal display.

EZ-STEP SIZE
04.000mA to 20.000mA
04 steps
04.000mA per step

Note: If the EZ-Stepä option is turned off, the display will flash "EZ-STEP OFF". Refer to Model 532 Configuration, section B.

To Change the EZ-Stepä Time:

1. Press and hold the UNITS/STEP TIME button for more than $\frac{3}{4}$ of a second.
2. The display will flash "EZ-STEP TIME".
3. Turn the EZ-Dialä knob to select from 5 to 900 second ramp time. The time per step is calculated based on the selected EZ-Stepä size.
4. Press the SOURCE/STEP SIZE button to return to the normal display.



EZ-STEP TIME
04.000mA to 20.000mA
005s ramp
001.250s per step

To Change the Soak Time:

1. Press and hold the READ/SOAK TIME button for more than $\frac{3}{4}$ of a second.
2. The display will flash "SOAK TIME".
3. Turn the EZ-Dialä knob to select from 0 to 900 second soak time.
Note: A soak time of 0 defeats the soak period. The step time will be used instead.
4. Press the READ/SOAK TIME button again to return to the normal display.

EZ-STEP SOAK TIME
04.000mA to 20.000mA
005s soak
001.250s per step

To Change the EZ-Step™ Direction:

1. Press and release the EZ-Dialä knob without turning.
2. The display will change to show the EZ-Stepä direction selected ( or ).



Model 532 Operating Instructions

I. Loop Diagnostic

Press and hold the **STORE/CLEAR/DIAGNOSTIC** button for more than 3/4 of a second to activate loop diagnostic mode. This is available in each of the Model 532's operating modes.

Read Modes:

Read Milliamps

Loop current is displayed.

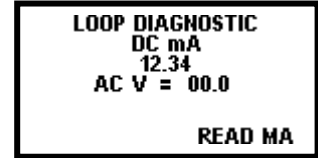

Power and Measure 2-Wire Transmitter

Loop current, voltage, and resistance is displayed.

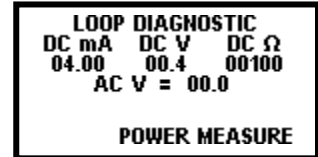

Read Volts

Voltage is displayed.

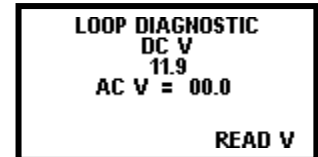

Source Modes:

The EZ-Dial knob, EZ-Check switch, and EZ-Step pushbutton function normally when the loop diagnostic is activated.

Source Milliamps

Loop current, voltage, and resistance is displayed. The resistance is highlighted if it exceeds the Model 532's output capability (1200 W at 20 mA with HART Compatibility disabled.)

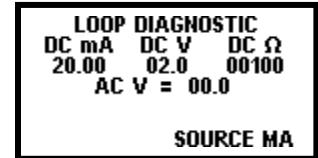

2-Wire Transmitter Simulate

Loop current is displayed. The Model 532 automatically performs a test every 7 seconds to compute the loop power supply voltage and loop resistance. The Model 532 requires approximately 2 volts across its terminals to operate in 2 Wire Simulate mode. The voltage display is highlighted if there is less than 2 volts present.

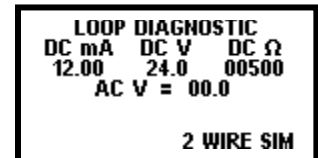

Source Volts

Loop current, voltage, and resistance is displayed. The resistance is highlighted if it exceeds the Model 532's output capability (20 mA into 1200 W with HART Compatibility disabled.)

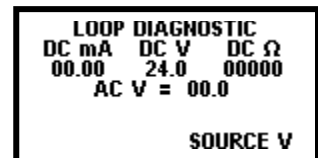



Model 532 Operating Instructions

In all loop diagnostic modes, AC voltage is displayed. If more than 2 VAC is present on the Model 532's terminals, the display is highlighted to alert the user of a potential problem.

In all loop diagnostic modes, HART activity is indicated with "© HART DETECTED ©". The © symbols flash on and off with the actual HART messages.

J. Modes of Operation

Read Milliamp

Connect the Model 532 in series with the process loop to monitor current. Observe correct polarity. Current limiting above 24.000 mA is indicated by a flashing "CURRENT LIMITED" display.

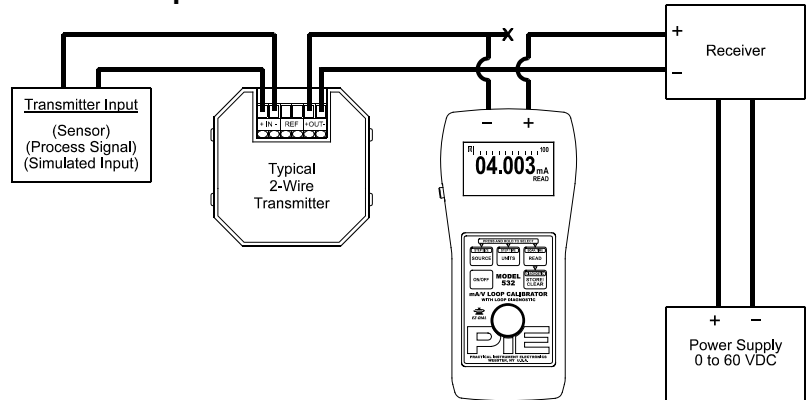

Power and Measure 2 Wire Transmitter

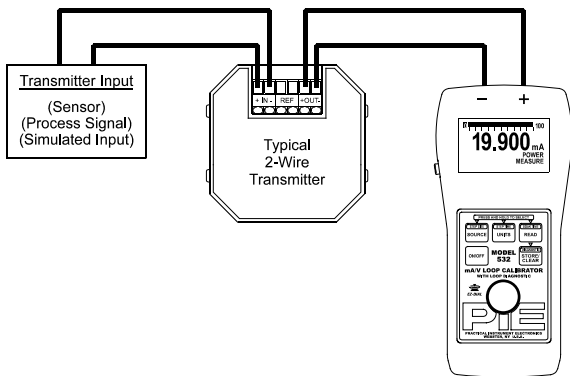

The Model 532 provides power to the process loop while displaying output current. Use this mode to test a transmitter's ability to control loop current. Current limiting above 24.000 mA is indicated by a flashing "CURRENT LIMITED" display.

Read Volts

The Model 532 measures +/- 30 VDC with 4X overrange ability. The display flashes "OVERRANGE" when the 30 volt limit is exceeded. 0.001 volt resolution below 24.00 volts provides the ability to calibrate 1-5 volt instrumentation.

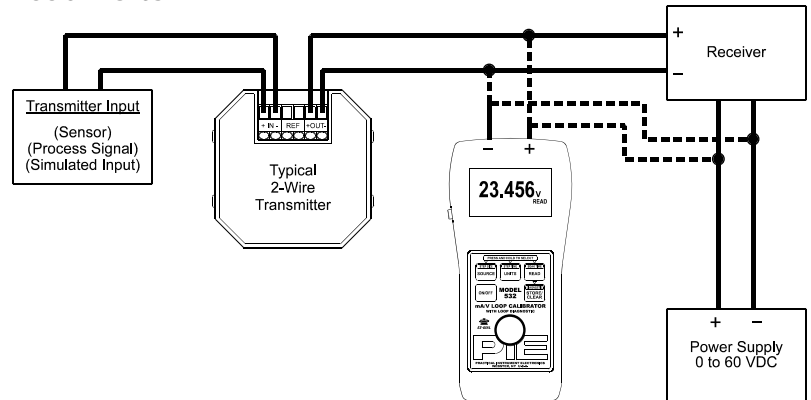

Source Milliamp

Connect the Model 532 directly to 4-20 mA receiver equipment, alarms, panel meters, etc. Use the EZ-Dialä Knob and EZ-Checkä Switch to adjust loop current. The display flashes "HIGH Ω" when the loop resistance is too high or the leads are open.

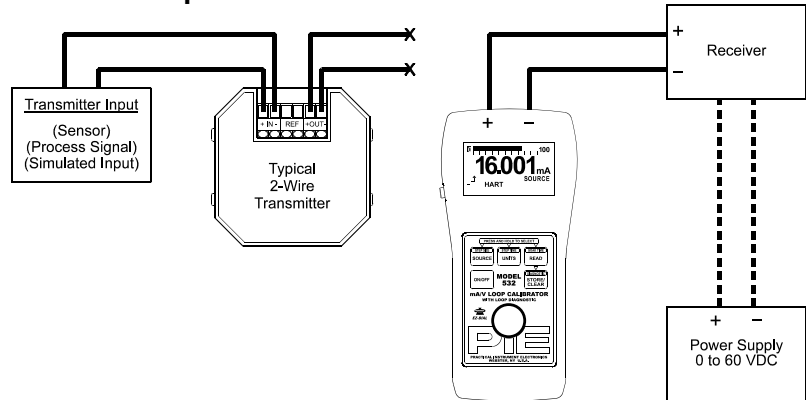

2 Wire Transmitter Simulate

Substitute the Model532 for a 2 wire transmitter. Use the EZ-Dialä Knob and EZ-Checkä Switch to adjust loop current. At least 2 volts of loop power is required, else the display flashes "CHECK LOOP SUPPLY."

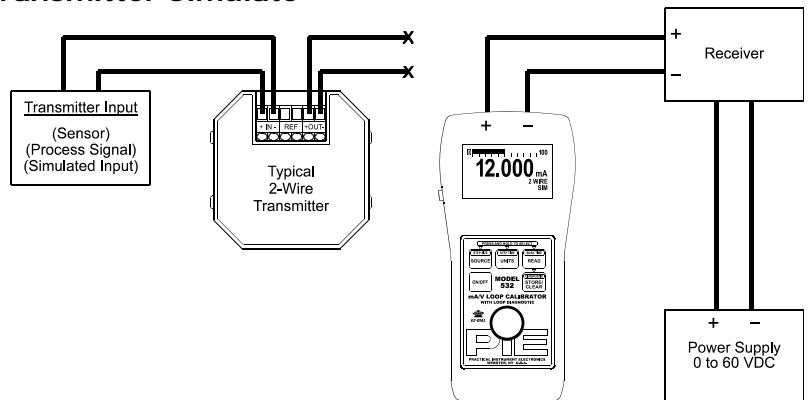

Source Volts

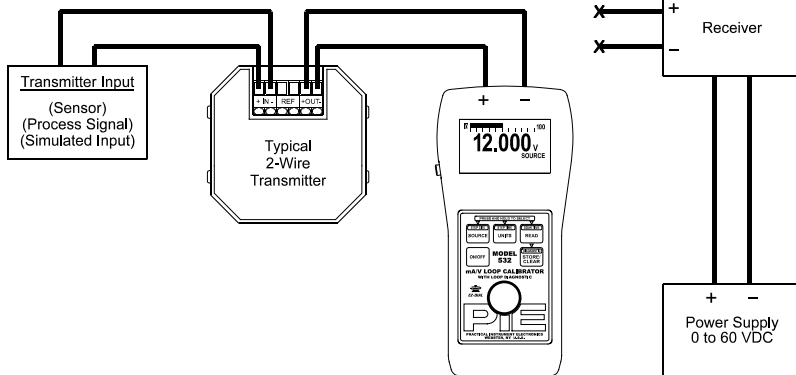

The Model 532 sources 0.000-24.000 volts. This is useful for powering transmitters and receiver equipment. Use the EZ-Dialä Knob and EZ-Checkä Switch to adjust output voltage. The display flashes "LOW W" when the output is overloaded.

K. Warranty

Our equipment is guaranteed against defective material and workmanship (excluding batteries) for a period of three years from the date of shipment. Claims under guarantee can be made by returning the equipment prepaid to our factory. The equipment will be repaired, replaced or adjusted at our option. The liability of Practical Instrument Electronics (PIE) is restricted to that given under our guarantee. No responsibility is accepted for damage, loss or other expense incurred through sale or use of our equipment. Under no condition shall Practical Instrument Electronics, Inc. be liable for any special, incidental or consequential damage.